



# HIGH PERFORMANCE AEROSOL GENERATORS AND NEBULIZERS

CATALOG 2024/2025 – MICRONICE®  
P&S AEROSOL GENERATOR RANGE

# 1. Table of contents

1.	Table of contents.....	1
2.	About Tekceleo .....	3
3.	Our solutions .....	4
4.	Micronice® Aerosol Generator working principles .....	5
4.1.	Mechanical principles .....	5
4.2.	Control principles .....	5
5.	P&S 360 SERIES.....	6
5.1.	Features.....	6
5.2.	Use cases and applications.....	7
5.2.1.	Industrial processes .....	7
5.2.2.	Decontamination .....	8
5.2.3.	Humidification.....	9
5.3.	Standard dimensions.....	10
5.4.	Specifications .....	10
5.4.1.	Output .....	10
5.4.2.	Inputs .....	11
5.4.3.	General characteristics.....	11
5.5.	P&S 360 fully functional kit.....	11
5.5.1.	Introduction .....	11
5.5.2.	Items included .....	12
5.5.3.	Overview .....	12
5.6.	Schematics on set-up possibilities.....	13
5.6.1.	Closed fluidic system with a pump.....	13
5.6.2.	Linear circuit with a drain.....	13
6.	P&S T45 SERIES.....	14
6.1.	Features.....	14
6.2.	Use cases and applications.....	15
6.2.1.	Aerosol and particles studies.....	15
6.2.2.	Aerosol sampling and calibration.....	16
6.2.3.	Filter testing .....	17
6.3.	Standard dimensions.....	18
6.4.	Specifications .....	18
6.4.1.	Output .....	18
6.4.2.	Inputs .....	19
6.4.3.	General characteristics.....	19
6.5.	P&S T45 fully functional kit.....	19

- 6.5.1. Items included .....20
- 7. Electronic controllers .....21
  - 7.1. Features .....21
  - 7.2. Specifications .....21
- 8. Customization and on-demand parts .....22
  - 8.1. Available customization .....22
    - 8.1.1. Droplet size .....22
    - 8.1.2. Temperature range .....23
    - 8.1.3. Other .....23
  - 8.2. Cables matrix .....23
  - 8.3. Accessories .....24
    - 8.3.1. HMI .....24
    - 8.3.2. Pump and ECU pump .....25
    - 8.3.3. Other .....25

## 2. About Tekceleo

Tekceleo is a French manufacturer of piezoelectric actuators of high quality. Our know-how is based on more than 20 years of works and manufacturing in piezoelectrics mechatronics devices.

We are known for our ability to provide creative and practical solutions focused on our client use cases. Our offer focuses on two product lines: Micronice® for aerosol generation actuator and Wavelling® for ultrasonic motors.

Tekceleo’s main market are pharmaceutical, medical, automation, measurement and aerospace industries. All our operations (design, manufacturing and marketing) are ISO 9001 certified. All our products are produced in our own facility in Mougins, South of France.

Our company is composed of a multidisciplinary team of engineers and physicists who have all the necessary tools to integrate the different technologies composing a product: mechanics, plastics, thermics, electronics and embedded software.

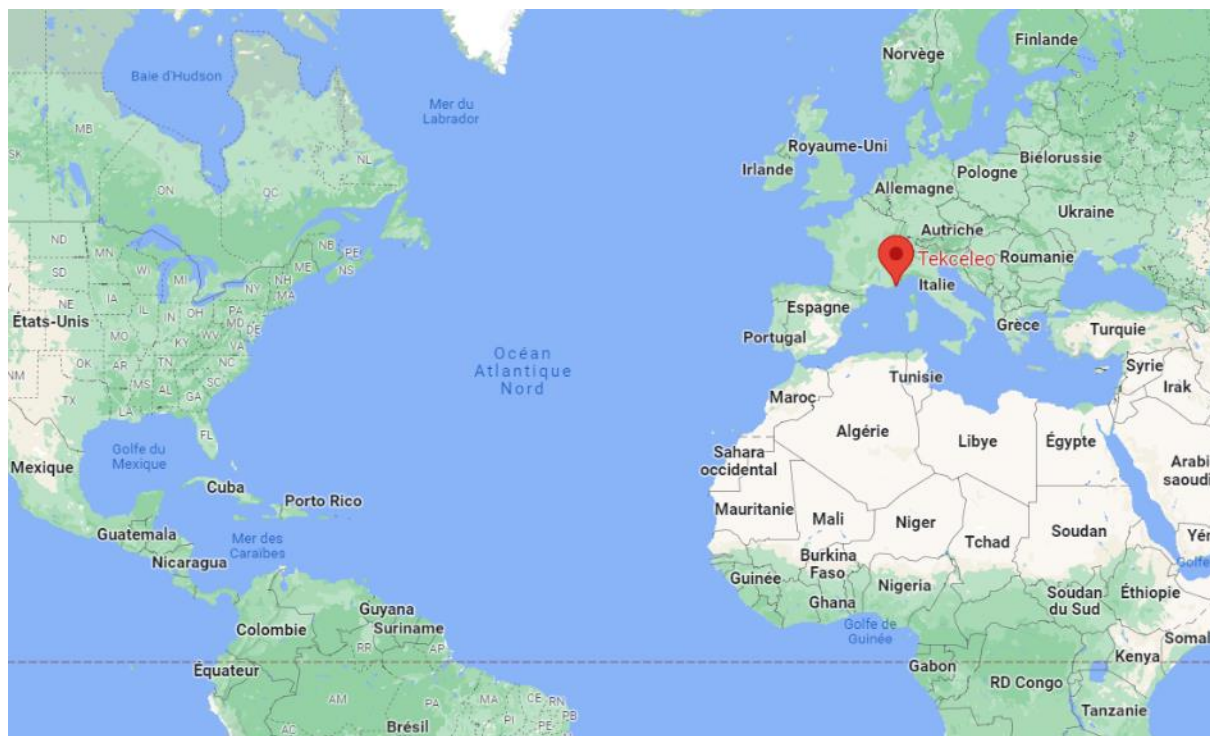

## 3. Our solutions



### MANUFACTURING

Tekceleo brings its craftsmanship and know-how in manufacturing best of the line piezo actuators. Our flexible manufacturing line allows customization and high reactivity.

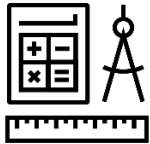

### ENGINEERING

We offer more than 20 years of experience in innovation. Each customer has different projects, expectations and goals. We can adjust our solution to fit your design. Our team of engineers brings support and consulting to add value to your project.



### PARTNERSHIP AND INTEGRATION

Tekceleo is here to help you get started with our technology. We help you throughout your integration process with our engineering team as a partner. We ensure confidentiality and support to our customer. We can also work as system integrators and technology consultants if needed.



### SUPPORT FROM EVALUATION TO PRODUCTION

Our value proposition is based on a complete support for our customers and partners in their industrialization process : design, prototyping, characterization, production and optimization. We help you to get through all your innovation cycle.

## 4. Micronice® Aerosol Generator working principles

### 4.1. Mechanical principles

The Tekceleo patented MICRONICE® technology is a breakthrough spray technology based on a low power amplified piezoelectric effect.

Thanks to the expertise of our team, we have developed a micro-perforated mesh device which, when vibrating at a certain frequency, expels the liquid as fine droplets perfectly calibrated (monodispersed).

Using the physical property of this principle, our technology allows to create calibrated aerosol. The fact that no heating, pressure or electricity is involved also preserves the liquid that is aerosolized. This is a key advantage when it comes to bioaerosol generation or for precise processes.

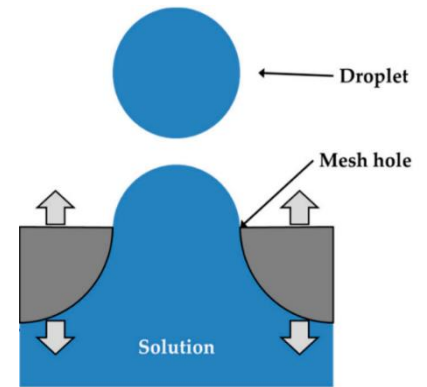

### 4.2. Control principles

Our amplified vibrating mesh technology work on two parameters :

- Tension
- Frequency

Our controllers are made to generate these parameters to always ensure that the membrane displacement reaches the right operating point. Our controllers ensure good flowrate without risking to put the membrane in a resonance disaster scenario.

The fact that this control is at ultrasonic frequency allows to directly control the spray flowrate with a duty cycle. Our controller can easily handle PWM control to set the flowrate. As a result, we are able to control flowrate of the nozzle with a great linearity, even with very small flowrate.

### Neb Flow Rate vs Duty Cycle

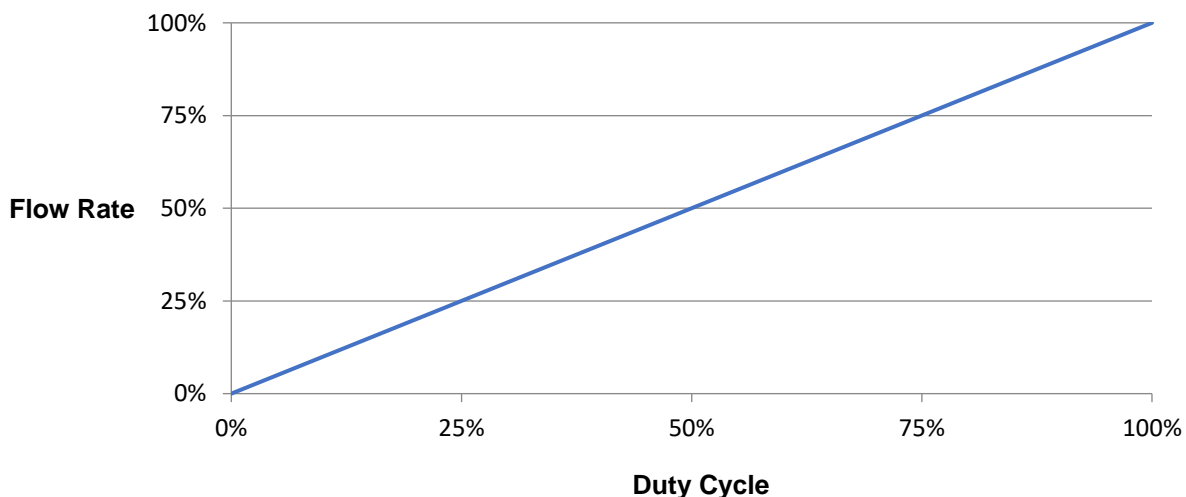

## 5. P&S 360 SERIES

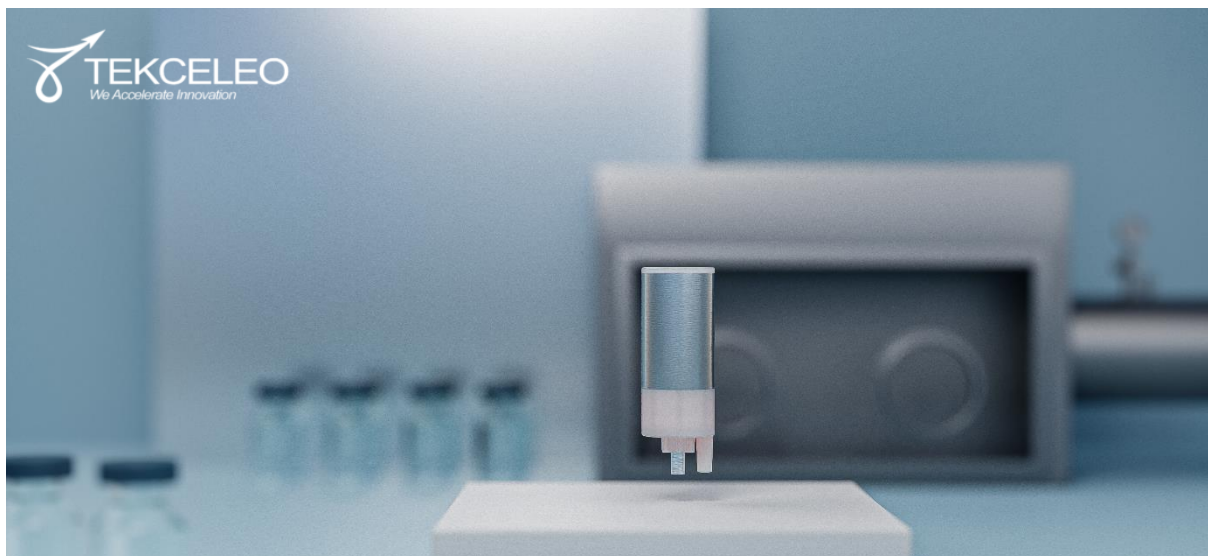

### 5.1. Features

The P&S 360 series has various features making it suitable for a wide variety of use cases :

- **Very low footprint ;**
- **Easy to use**, as it is a “plug and spray” device ;
- Easy to mount and integrate to every volume or place where it is needed. Electronics can be deported ;
- **Adaptable flowrate and droplet size**, allowing for a large variety of uses ;
- Circulating fluidic system functioning on closed loop or with drains ;
- **Very low power consumption** (< 2W per nozzle) ;
- **No noise** during operation ;
- **No heating** nor pressure rise during operation ;
- Very easy to control via electronics (PLC, HMI, etc.) ;
- **Can support corrosive liquid and high temperature of operation.**

P&S 360 design is well suited for most automated industrial use cases, from humidity control, generation of industrial aerosols or decontamination of volume.

Our P&S 360 nozzles come with 5 standard droplet size : 05 µm, 08 µm, 12 µm, 20 µm and 50 µm. More information regarding our standard nozzles in the Specifications section of the catalog.

## 5.2. Use cases and applications

### 5.2.1. Industrial processes

The Micronice® nebulization technology, patented by Tekceleo, is used in a wide range of industrial processes requiring the precise generation of aerosols or sprays. At the heart of challenging processes, our technology is easily integrated thanks to its electronic control via software and its response time of less than a millisecond. Thus, our spray heads can easily be implemented in an industrial chain for any type of process :

- Coating ;
- Thin films ;
- Creation of micro-spheres and capsules ;
- Pharmaceutical spray drying (dry powder generation) ;
- Additive manufacturing.

Each application can benefit from our calibrated aerosol generation, which allows to perfectly master the aerosolization process.

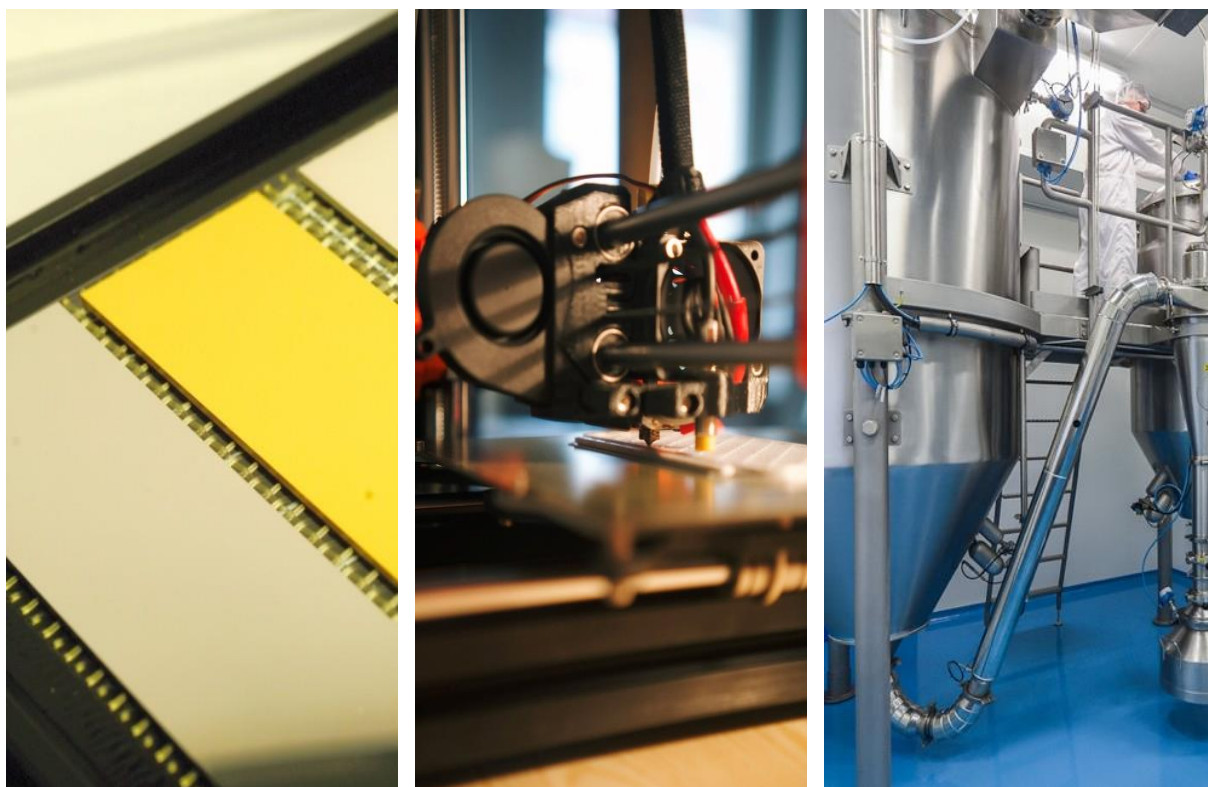



### 5.2.2. Decontamination

Our technology is suitable for multiple sterilization and decontamination use cases: **it works both with Hydrogen Peroxide and Peracetic Acid, using cold-temperature nebulization.** Our nozzles are made to be easily integrated in all equipment, regardless of the sector. **In the right configuration they achieve the EN 17-272 norm for airborne disinfection, which means reaching log 4 to 6 for bacteria, viruses and fungi.**



Right now, our technology is integrated in many automated decontamination devices such as :

- **Portable automated H2O2 (hydrogen peroxide) decontamination foggers ;**
- **Isolators, as integrated hydrogen peroxide sprayers ;**
- **Biological Safety Cabinet (BSC), as integrated hydrogen peroxide sprayers ;**
- **Airlock, as integrated hydrogen peroxide foggers ;**
- **Aseptic packaging machine for food industries, as integrated hydrogen peroxide foggers.**

Our technology is very appreciated in **H2O2 decontamination for small or medium sized volume.** Indeed, our ability to produce very small droplets (05 µm) allows for same efficiency as VHP (vaporized hydrogen peroxide) devices but without the disadvantages. Indeed, our system remains small, easy to integrate and allows for short decontamination cycles (between 15mn to 1h).



### 5.2.3. Humidification

Tekceleo's Plug & Spray humidification products can be used as humidifiers for various processes :

- **Food processing applications.** It can preserve food over time by humidifying it without wetting surfaces.
- **Aeroponics controlled environments.** P&S 360 can either maintain the right relative humidity or be used as a sprayer for feeding roots of the plants.
- **Automated and localized humidification for processes.** For example, adhesive activation, or treatment of surfaces.
- **Controlled environment humidifiers,** with their very precise and easily controlled flowrate our nozzle can control relative humidity for special processes in food, pharma or chemical industries.

Use of Tekceleo's nebulizers for precise humidification allows to **save space, consumables and energy.** The very short fluidic response time of our nozzle couple to a very controlled flowrate and droplet size makes it a solution for a wide variety of humidification use case.



### 5.3. Standard dimensions

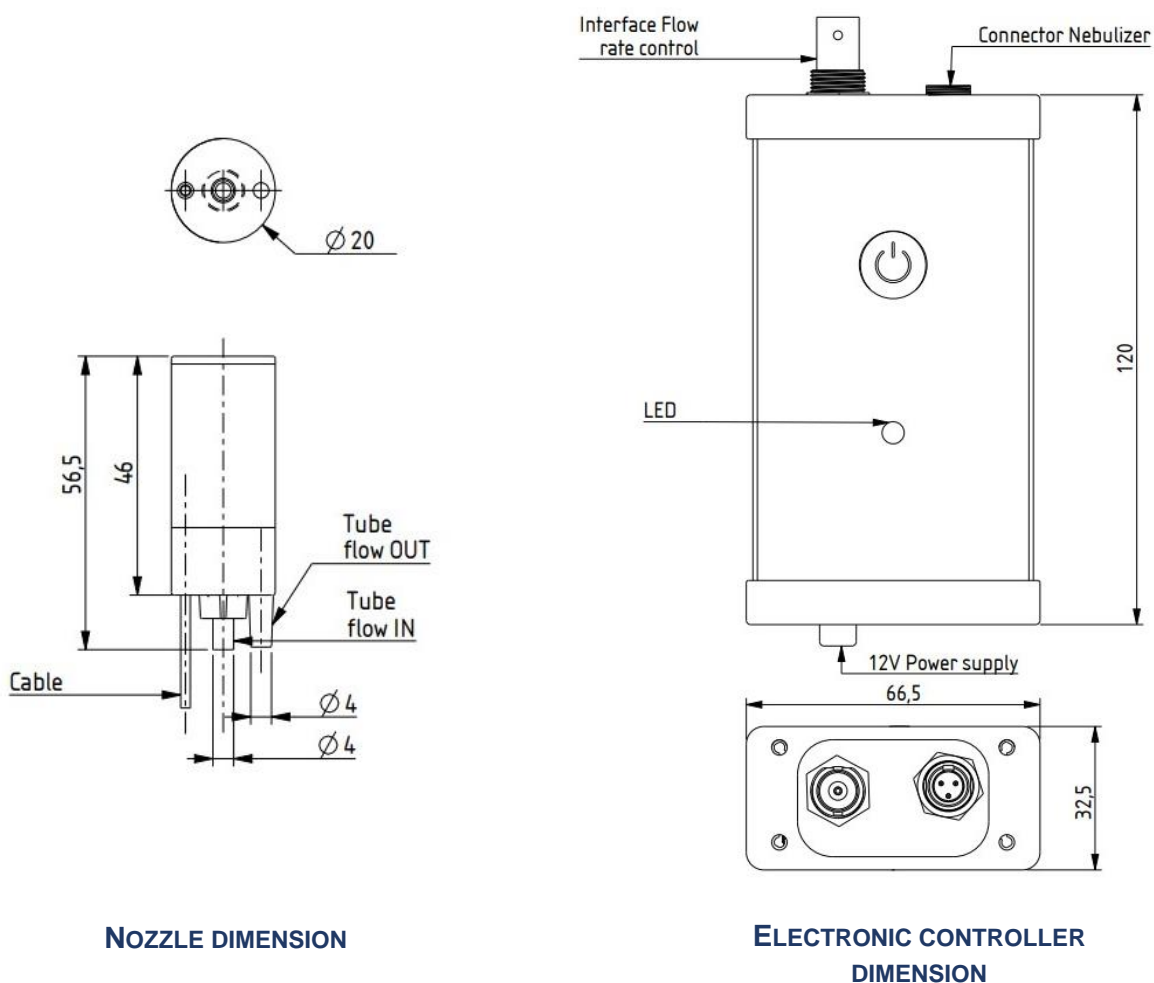

### 5.4. Specifications

#### 5.4.1. Output<sup>1</sup>

Nozzle ref	Droplet size	Nominal output per nozzle (+/- 20%)	Nominal output per nozzle (+/- 20%)	Max nozzles per controller (simultaneous control)	Nominal output per controller/nozzles set-up (+/- 20%)
H360 – M05	05 µm	0,8 ml.mn	0,05 L.h	10 nozzles	0,5 L.h
H360 – M08	08 µm	2,5 ml.mn	0,15 L.h		1,5 L.h
H360 – M12	12 µm	5,5 ml.mn	0,33 L.h		3,3 L.h
H360 – M20	20 µm	8 ml.mn	0,48 L.h		4,8 L.h
H360 – M50	50 µm	35 ml.mn	2,1 L.h		21 L.h

<sup>1</sup> Our Output are measured with reverse osmosis water (RO Water) with conductivity >20µS.cm

### 5.4.2. Inputs

Nozzle ref	Power supply	Power consumption	Water supply system	Water supply max pressure	Control system
H360 – M05	12 VDC – 60cm standard cable length	< 160 mA per nozzle	Circulating fluidic system with I/O plug for tubing	<0,1 bar Working on circulating fluidic system	12 VDC power supply (adapters compatible to 110 and 220 V power supply)  PWM interface (3.3V) on BNC connector
H360 – M08					
H360 – M12					
H360 – M20					
H360 – M50					

### 5.4.3. General characteristics

Nozzle ref	Weight (cabled nozzle)	Nozzle materials	System tubing	Temperature range	Average lifespan under normal condition of use
H360 – M05	35 g	SS304, SS316 and HDPE	Ø 3mmx5mm nozzle feeding silicone tubes	-20°C to 80 °C Work only on liquid	10 000 hours  <i>Lifespan may vary depending on liquid and condition of uses</i>
H360 – M08					
H360 – M12					
H360 – M20					
H360 – M50					

## 5.5. P&S 360 fully functional kit

### 5.5.1. Introduction

In order to easily use directly our Micronice technology, **we provide a fully functional kit.** Main purpose of this kit is to start prototyping and playing with our aerosol generation technology to get started.

However, these kits are also fully functional devices that **can be directly use for all applicable use cases : decontamination (H2O2 fogging), humidification or even industrial processes.**

Kit can be purchased at any time and for any droplet size or configuration needed. **Just contact us on our website :**

[www.tekceleo.com](http://www.tekceleo.com)

### 5.5.2. Items included



#### LIST OF ITEMS INCLUDED IN THE P&S 360 KIT

The P&S 360 functional kit includes :

- One nozzle and a tripod to mount it.
- One controller.
- One HMI to easily get started (touch-screen displayer for easy control). It allows to ON/OFF, set flowrate and duty cycle.
- One fully functional fluidic system : pump, pump’s controller, reservoir and tubing.
- All needed cables.

### 5.5.3. Overview

Dimension of the kit (LxWxH) :  
30 cm x 25 cm x 20 cm

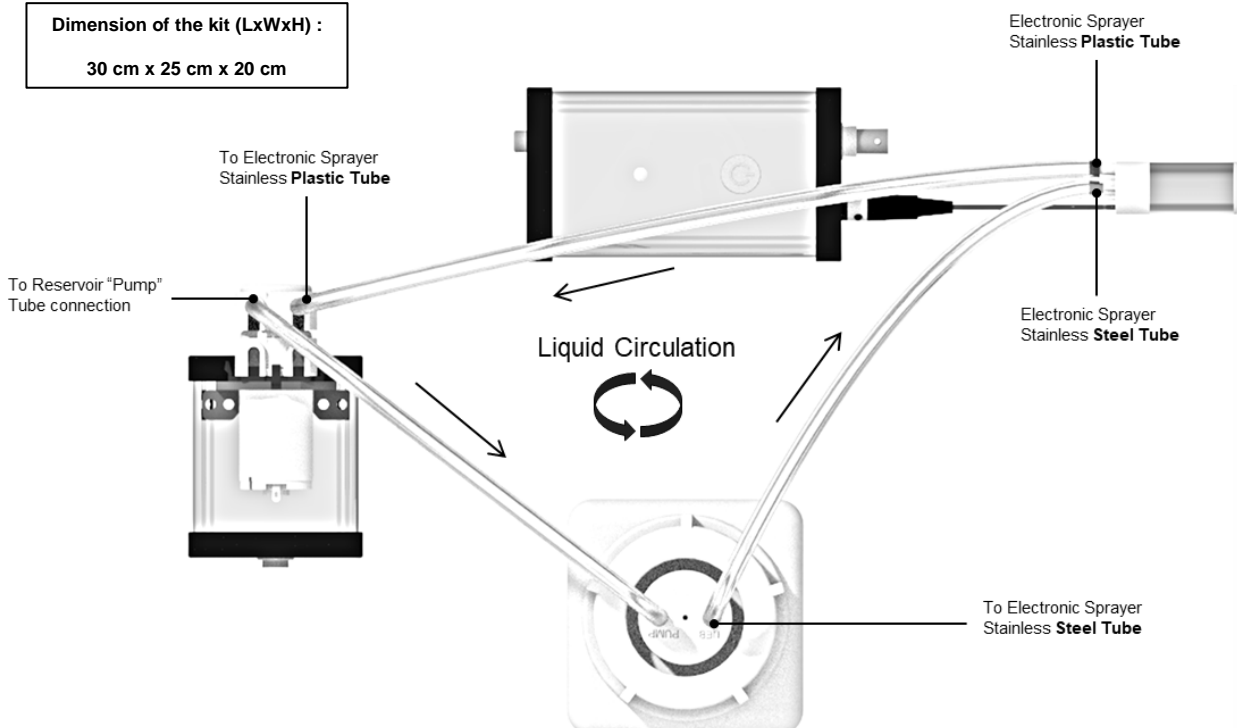

## 5.6. Schematics on set-up possibilities

### 5.6.1. Closed fluidic system with a pump

This set up is ideal **for industrial processes that requires precision on aerosol flowrate generation**, as well as wasting as little liquid as possible during operation.

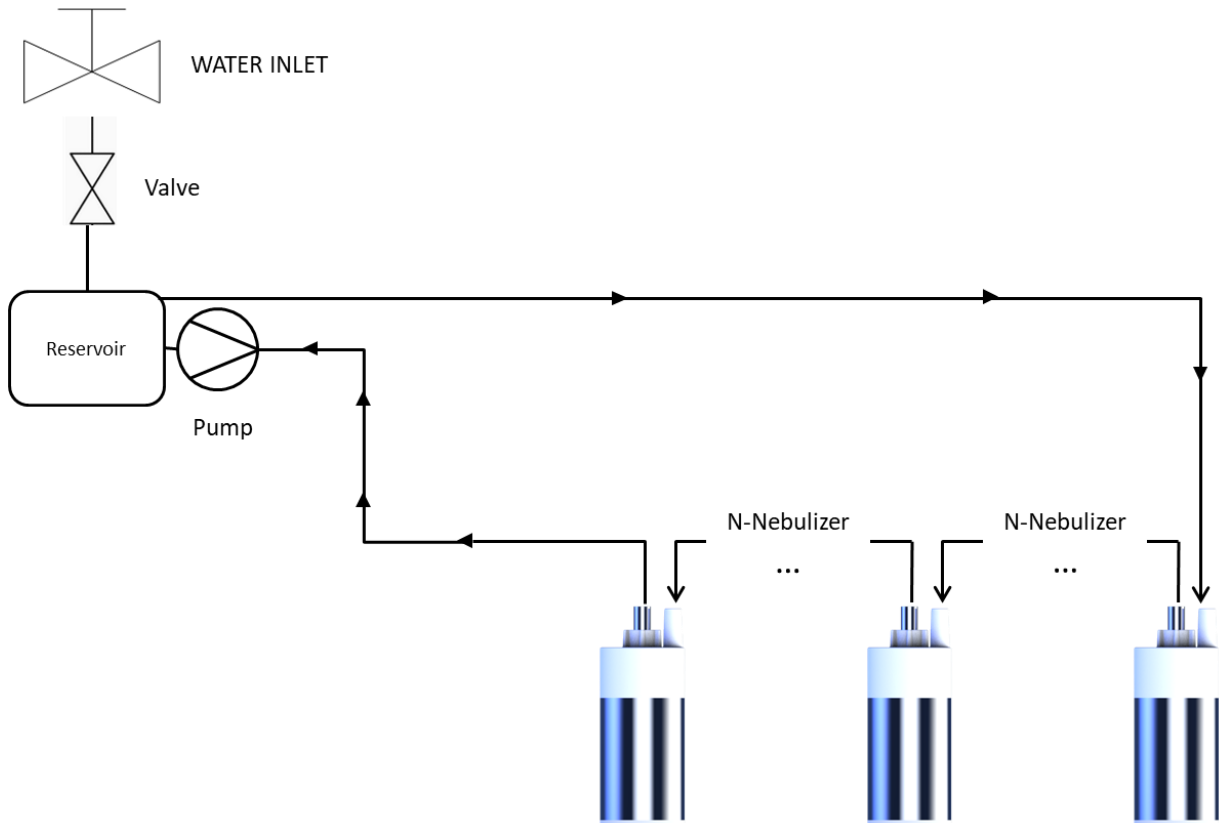

### 5.6.2. Linear circuit with a drain

This set up is convenient for **simple humidification set ups**. It avoids the need to deal with stagnant water and allows for easy installation of nozzles in operation.

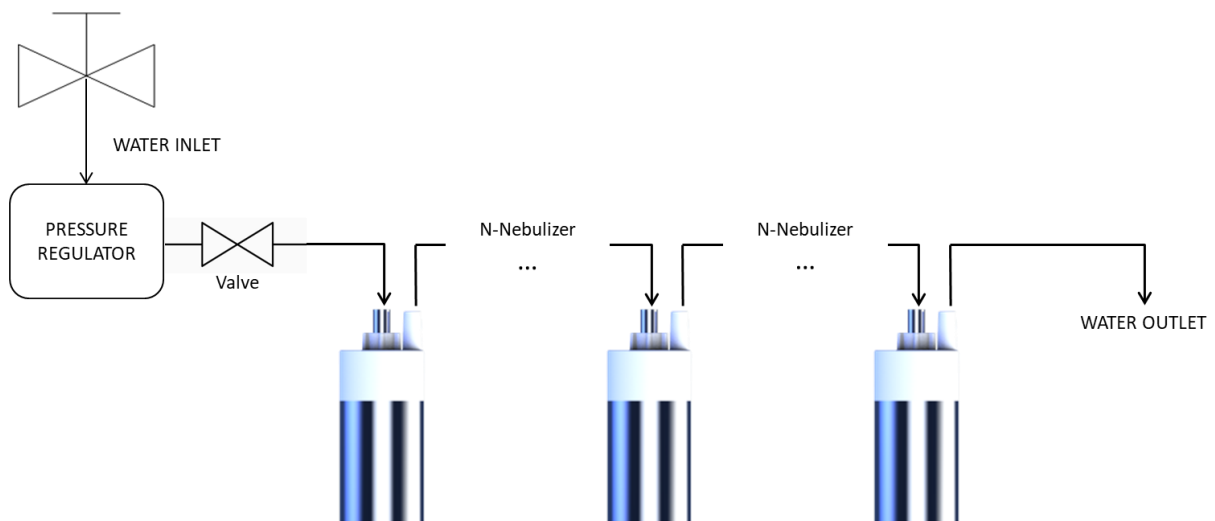

## 6. P&S T45 SERIES

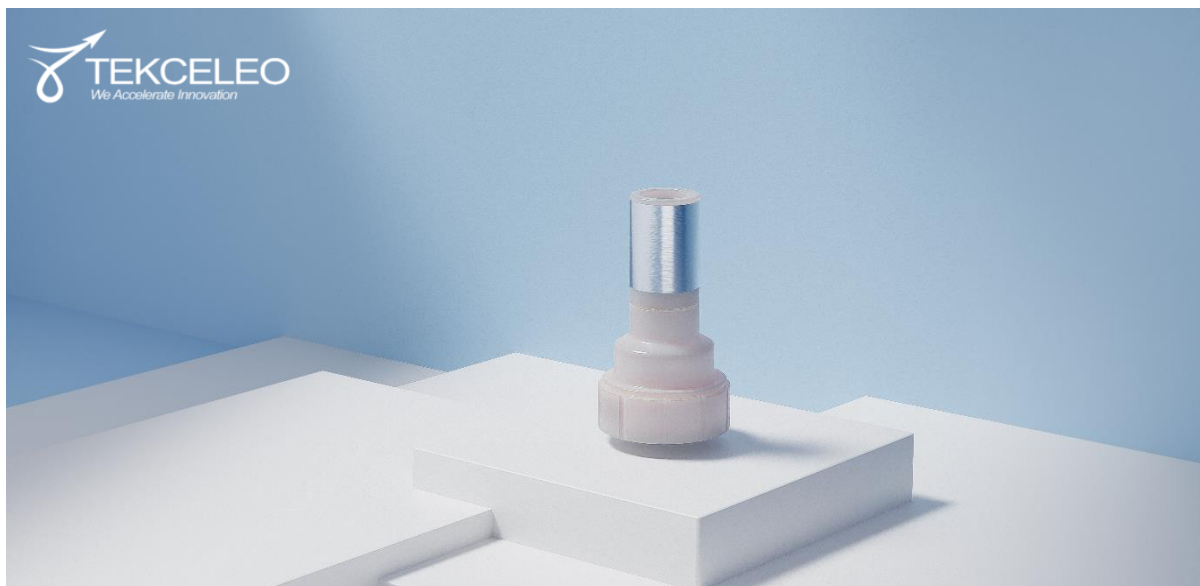

### 6.1. Features

The P&S T45 series has various features making it suitable for a wide variety of use cases :

- Very low footprint ;
- Easy to use, as it is a “plug and spray” device ;
- **Easy to handle : easy to fill and clean 10 mL integrated tank ;**
- Ergonomic design to handle and fix it anywhere needed ;
- **Adaptable flowrate and droplet size**, allowing for a large variety of uses ;
- **No dead volume**, can be used with very precise or valuable liquid sample ;
- No noise during operation ;
- **No heating nor pressure rise during operation ;**
- Very easy to control via electronics (PLC, HMI, etc.) ;
- **Can support corrosive liquid and high temperature of operation.**

P&S T45 design is well suited for most laboratory research, R&D aerosol testing, precise sample aerosolization. It is design to be easy to test, experiment and play with various variables around aerosol generation.

**The P&S T45 is available in a Very High Temperature range that can operate up to +200 °C.**

## 6.2. Use cases and applications

### 6.2.1. Aerosol and particles studies

Tekceleo's Micronice nebulization technology is commonly used for precise atomization of relatively low viscosity liquids (viscosity < 3mPa.s). Our droplet generators are based on the concept of vibrating mesh nebulization, **which atomizes the liquid without increasing temperature or pressure**. In addition, our simple and modular design, a simple kit, is perfectly adaptable to any research environment.

**Our devices can guarantee monodispersed aerosol particles and no alteration of the atomized solutions**, which is particularly appreciated in the context of aerosolization of pharmaceutical and biologic formulations. Among our customers, the most common laboratory uses for our scientific atomization solution are:

- **Microbiology** (microorganisms, fungi, etc.) ;
- Medical research (bacteria, viruses, pollen...);
- **In-vitro testing** ;
- Thermal and material study (Coating, nuclear studies...);
- Study of aerosol behaviour (airflow mapping, etc.).





## 6.2.2. Aerosol sampling and calibration

T45 design is perfectly suited for precise sampling of aerosols and for calibration of devices. The “Plug & Spray” design allows to produce a wide range of calibrated droplets :

- 05  $\mu\text{m}$
- 08  $\mu\text{m}$
- 12  $\mu\text{m}$
- 20  $\mu\text{m}$
- 50  $\mu\text{m}$

From 04  $\mu\text{m}$  to 100  $\mu\text{m}$ , we can customize the membrane of our nozzles to precisely calibrate the aerosol you need. **Precise droplet size distribution graph can be added in order to set the particle size and the aerosol generation flowrate as a standard value for you use case.** As a result, our Micronice T45 set up can be used as a sampling device or a calibrating aerosol generator.



### 6.2.3. Filter testing

In order to test air purifiers and air-filters, and assess their effectiveness (results in terms of reduction of viral or bacterial loads) it is necessary to create environments that simulate real situations and bacteria/viral exposure. These tests consist in introducing a controlled concentration of viruses, bacteria, particles or other contaminant into closed chambers via precision aerosol generators.

**The Micronice® T45 allows to aerosolize precise amount of bacteria, viruses, fungi, spores or other needed particles to test the efficiency of such filters.** Micronice® technology and design is able to accurately spray samples of bacteria or viruses to replicate an infected environment without prior damage, so the efficiency of the air purifiers can be perfectly evaluated. The main advantages of our technology are the following :

- **Very precise amount of nebulized particles.** With no dead volume, scientists are able to control the exact amount of contaminants they spray.
- **No rise in temperature or in pressure.** The aerosol produced is very similar to ambient aerosol, no contaminant is damaged.
- **Control on the droplet size, allowing to simulate various cases.**
- **Easy to fill, set up and clean, gaining time for testing samples.**



### 6.3. Standard dimensions

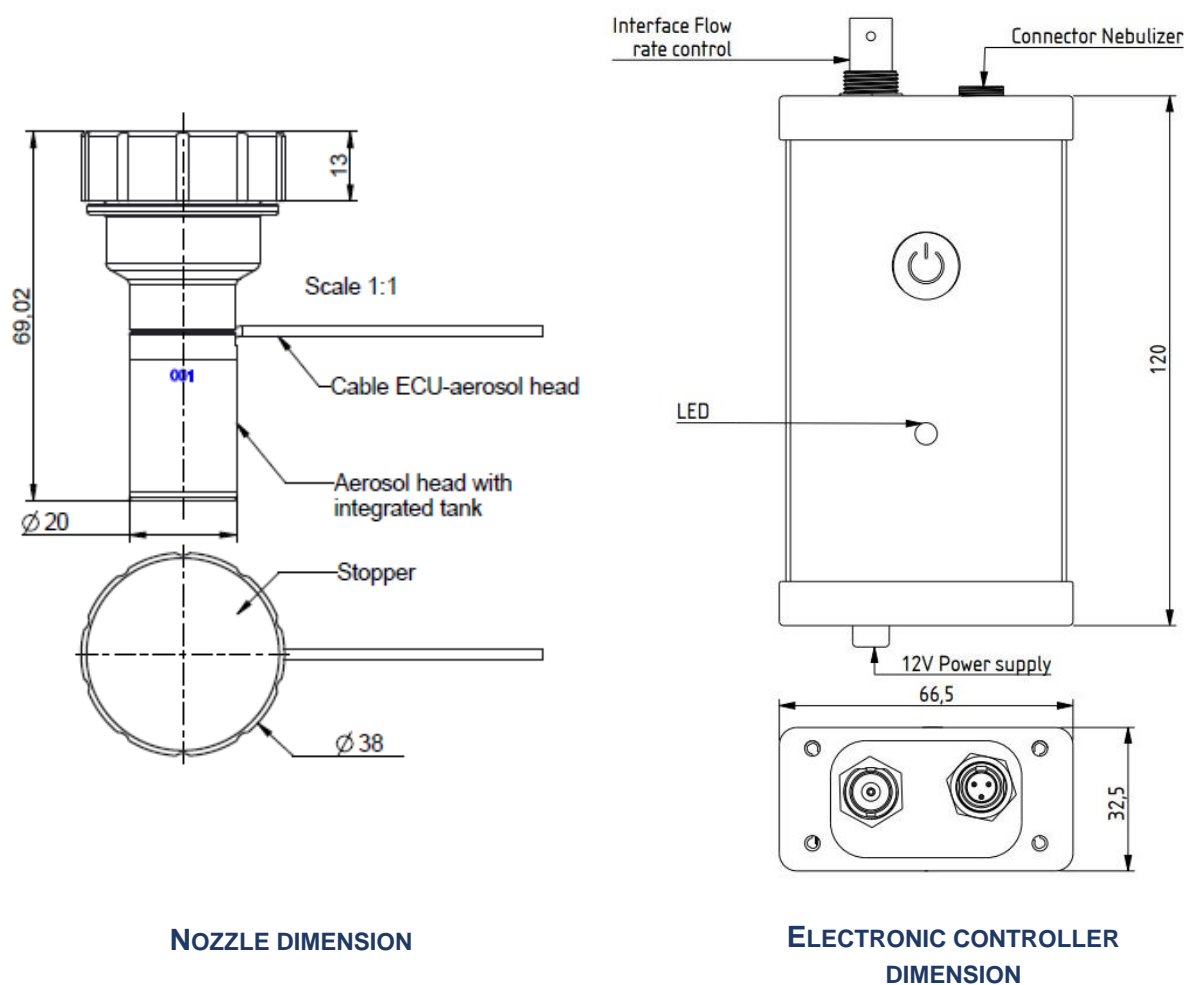

**NOZZLE DIMENSION**

**ELECTRONIC CONTROLLER DIMENSION**

### 6.4. Specifications

#### 6.4.1. Output<sup>2</sup>

Nozzle ref	Droplet size	Nominal output per nozzle (+/- 20%)	Nominal output per nozzle (+/- 20%)	Max nozzles per controller (simultaneous control)	Nominal output per controller/nozzles set-up (+/- 20%)
H-T45 – M05	05 µm	0,8 ml.mn	0,05 L.h	10 nozzles	0,5 L.h
H-T45 – M08	08 µm	2,5 ml.mn	0,15 L.h		1,5 L.h
H-T45 – M12	12 µm	5,5 ml.mn	0,33 L.h		3,3 L.h
H-T45 – M20	20 µm	8 ml.mn	0,48 L.h		4,8 L.h
H-T45 – M50	50 µm	35 ml.mn	2,1 L.h		21 L.h

<sup>2</sup> Our Output are measured with reverse osmosis water (RO Water) with conductivity >20µS.cm

### 6.4.2. Inputs

Nozzle ref	Power supply	Power consumption	Water supply system	Water supply max pressure	Control system
H-T45 – M05	12 VDC – 60cm standard cable length	< 160 mA per nozzle	10 mL integrated tank	<0,1 bar	12 VDC power supply (adapters compatible to 110 and 220 V power supply)
H-T45 – M08					
H-T45 – M12					
H-T45 – M20					
H-T45 – M50					PWM interface (3.3V) on BNC connector

### 6.4.3. General characteristics

Nozzle ref	Weight (cabled nozzle)	Nozzle materials	System tubing	Temperature range	Average lifespan under normal condition of use
H-T45 – M05	40 g	SS304, SS316 and POM	N/A	-20°C to 80 °C	10 000 hours <i>Lifespan may vary depending on liquid and condition of uses</i>
H-T45 – M08				Work only on liquid	
H-T45 – M12				-20 °C to +200 °C <i>version on-demand</i>	
H-T45 – M20					
H-T45 – M50					

Other droplet size on-demand : 24 µm, 30 µm, 39 µm, 46 µm, 65 µm... Customization of droplet size is possible.

## 6.5. P&S T45 fully functional kit

In order to easily use directly our Micronice technology, we provide a fully functional kit. Main purpose of this kit is to directly use our T45 aerosol generation technology.

**This kit is made to be a fully functional device that can be directly use for all applicable use cases : aerosol generation, lab experiment, coating, etc.**

Kit can be purchased at any time and for any droplet size or configuration needed. **Just contact us on our website :**

[www.tekceleo.com](http://www.tekceleo.com)

### 6.5.1. Items included



H-T45 Electronic sprayer



ECU NEBx01  
MXX with Casing



Protective  
cap



Tripod



12V Power  
Supply



BNC Cable



1x DC-DC Cable



IHM P&SMXX

#### LIST OF ITEMS INCLUDED IN THE P&S T45 KIT

The P&S T45 functional kit includes :

- One nozzle and a tripod to mount it.
- One controller.
- One HMI to easily get started (touch-screen displayer for easy control). It allows to ON/OFF, set flowrate and duty cycle.
- All needed cables.

## 7. Electronic controllers

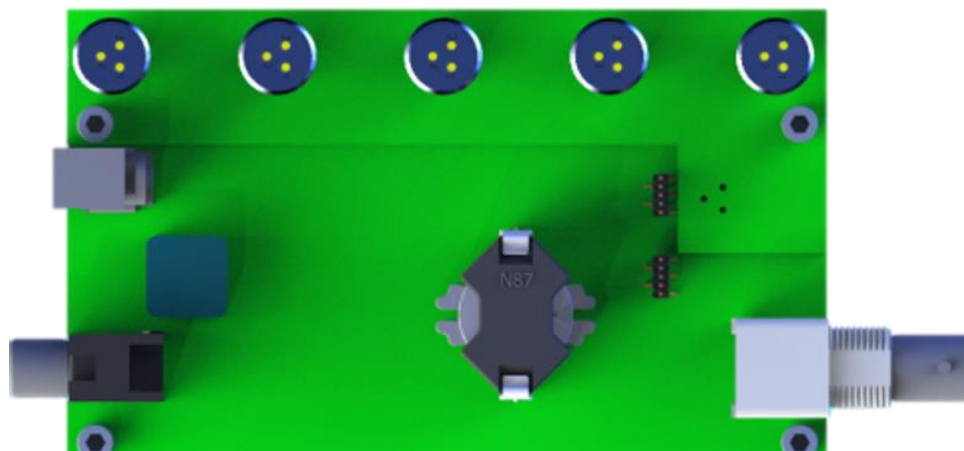

### 7.1. Features

Our electronic controllers work on both P&S 360 and P&S T45 nozzles. They allow for :

- Continuous operation.
- PWM control of the nozzle, for ON/OFF and flowrate control.
- Multiple nozzle control (simultaneous operation), from 1 to 10 nozzles.

Our controllers are on different design depending on how much nozzle they are meant to control :

- ECU x1 (available with casing)
- ECU x2 (casing on-demand)
- ECU x3
- ECU x4
- ECU x5
- ECU x6
- ECU x7
- ECU x8
- ECU x9
- ECU x10

Current consumption depends on how much nozzle they are able to control. With a ratio of 180 to 250 mA per nozzle.

### 7.2. Specifications

	Supply voltage	Current consumption per nozzle	Dimension	PWM control
ECU Neb XX	12 Vdc	180 mA – 250 mA	120 x 66,5 x 32,5 mm	BNC connector at 3.3 V Frequency : 150 Hz

## 8. Customization and on-demand parts

### 8.1. Available customization

#### 8.1.1. Droplet size

Droplet size	Flowrate <sup>3</sup>	Availability	High temperature version	Electronic control	P&S T45 version	P&S H360 version
05 µm	0,8 ml/min	Standard	On-demand	YES	YES	YES
08 µm	2,5 ml/min	Standard	On-demand	YES	YES	YES
12 µm	5,5 ml/min	Standard	On-demand	YES	YES	YES
17 µm	4,5 ml/min	On-demand	On-demand	YES	YES	YES
20 µm	8 ml/min	Standard	On-demand	YES	YES	YES
24 µm	15 ml/min	On-demand	On-demand	YES	YES	YES
30 µm	20 ml/min	On-demand	On-demand	YES	YES	YES
39 µm	27,5 ml/min	On-demand	On-demand	YES	YES	YES
46 µm	35 ml/min	On-demand	On-demand	YES	YES	YES
50 µm	35 ml/min	Standard	On-demand	YES	YES	YES
65 µm	70 ml/min	On-demand	On-demand	YES	NO	YES

***All droplet sizes between 04 µm and 100 µm can be developed as a custom-made nozzle.***

<sup>3</sup> Nominal flow rate with RO Water. For more details, contact Tekceleo.

## 8.1.2. Temperature range

### Standard design :

- -20 °C to 80 °C.
- For P&S 360 and P&S T45 design.

### High temperature design :

- - 20°C to 200 °C.
- Only available for P&S T45 design.

## 8.1.3. Other

All customization can be considered upon requests. **Just contact us on our website :**

[www.tekceleo.com](http://www.tekceleo.com)

## 8.2. Cables matrix

Ref	Connector Housing	Length
Standard nozzle cable	Mini-XLR female	60 cm
1m cable extension (nozzle)	Mini-XLR male to female	1 m
2,5m cable extension (nozzle)	Mini-XLR male to female	2,5 m
5m cable extension (nozzle)	Mini-XLR male to female	5 m
HMI – ECU BNC (PWM)	Coaxial cable with male BNC connector	50 cm
ECU power supply	12 V 2A - DC tip size : 5.5*2.1mm	80 cm
HMI power supply	12 V 2A - DC tip size : 5.5*2.1mm	80 cm

***All our nozzle design has the same cable and connectors. Connectors can be changed upon requests.***



## 8.3. Accessories

### 8.3.1.HMI

- All droplet size are compatible with the HMI
- Control function:
  - o Real-time user guide on interface
  - o Flow variation from 1% to 100%
  - o On / off timer with number of cycles: Programmable with x second on and y second off
  - o Timer with one cycle: Programmable with x second on
  - o Integrated pump control

HMI P&S Mxx PLUG & SPRAY	
Power supply	12VDC
Power consumption	12VDC/150mA
Touch Interface	3.5 inch
Power supply to HMI cable length	80 cm
Cable lengths HMI to electronic box	50 cm
HMI P&S Mxx Control features	
Nebulizer and Pump	Touch On / Off
Flow Rate	Variation from 1% to 100% touch
On/Off Cycle	Choice of x second "on" and x second "off" with a defined number of cycles (by multiple of one second)
On Cycle	Choice of x second "on" under a single cycle (by multiple of one second)

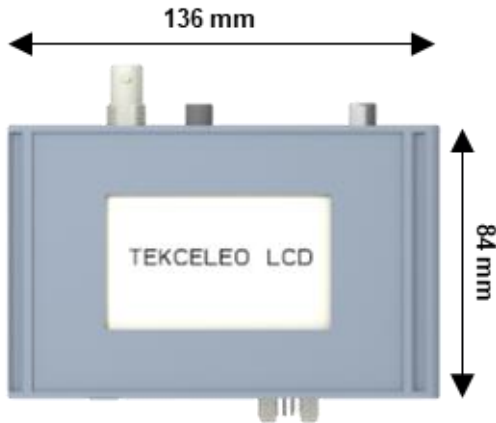

**HMI P&S MXX**  
Dimensions : 136 x 84 x 44,2 mm



RCA Cable : 50 cm



BNC Cable : 50 cm



12V Power Supply : 80 cm



DC-DC Cable : 50 cm

### 8.3.2. Pump and ECU pump

To easily get started with a circulating fluidic system we provide a pump and its controller already designed for our P&S 360 design nozzles. The pump used is a peristaltic pump.

Peristaltic Pump specifications :

- Flow Rate : 155 ml/min
- Current Consumption : 0.5 A
- Supply Voltage : 12V

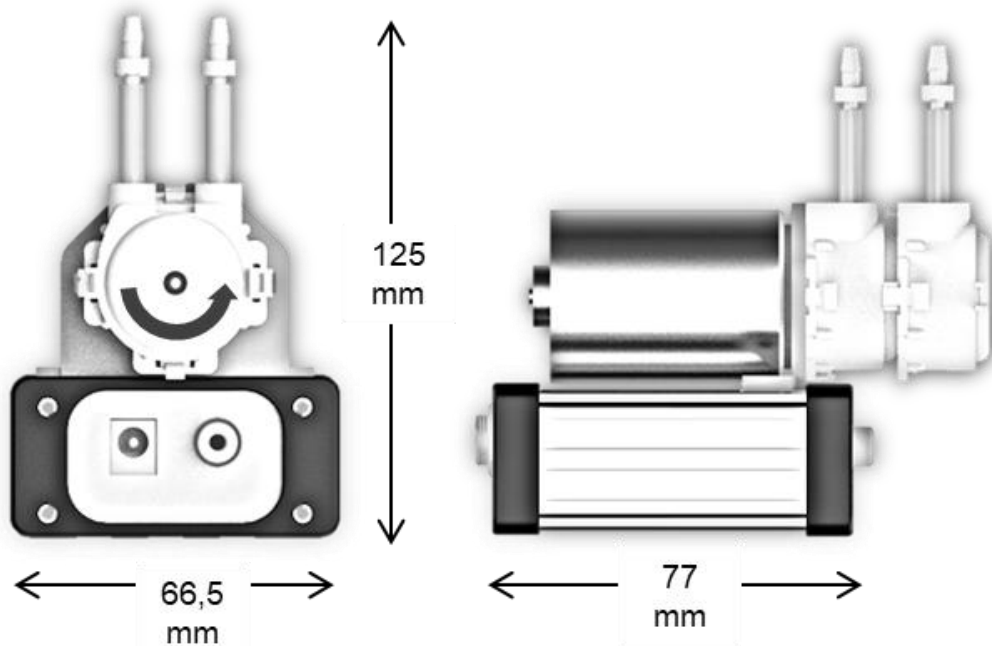

**STANDARD PUMP AND ITS ECU  
DIMENSION**

### 8.3.3. Other

Tekceleo can provide guidance and/or supply for all other needed components for your set-up :

- Fluidic system parts :
  - Tubing
  - Pump
  - Holding parts
  - Flowrate regulators
- Electronics :
  - Cables
  - Connectors
  - Controllers

**Feel free to contact us and we'll gladly help you find the solution you need !**



**Contact us at :**

[www.tekceleo.com](http://www.tekceleo.com)